

October 2002

A Hand Up for Michigan Workers

*Creating a State Earned
Income Tax Credit*

*Prepared for
the Michigan Catholic Conference*

By Patrick L. Anderson
Anderson Economic Group, LLC

**Michigan
Catholic
Conference** 

October 15, 2002



A Hand Up for Michigan Workers

Creating a State Earned Income Tax Credit

*Prepared for
the Michigan Catholic Conference*

Patrick L. Anderson
Anderson Economic Group, LLC
615 W. Ionia
Lansing Michigan 48933
517.374.2596

<http://www.AndersonEconomicGroup.com>

Table of Contents

Transmittal Letter	4
.....	5
About the Michigan Catholic Conference	5
About the Author	5
Executive Summary	6
Payroll Taxes: The Punishment of the Worker	6
The Earned Income Tax Credit	6
<i>The Workers' Share of Labor Costs</i>	7
A Michigan EITC	7
Conclusions & Recommendations	8
Conclusions	8
Recommendations	9
Income and Payroll Taxes	10
Federal Income Taxes	10
State and Local Income Taxes	10
OASDI (Social Security and Medicare) Taxes	11
FUTA (Federal Unemployment Tax Act)	11
Unemployment Insurance	11
Who Pays Payroll Taxes?	11
Example: Taxes on the Household Worker	12
Example: Taxes on the Self-Employed	13
Who Benefits from Payroll Taxes?	13
Summary of Payroll and Income Taxes	14
<i>Income and Payroll Taxes in the State of Michigan, 2002</i>	15
<i>Effective Tax Rates, Selected Income & Payroll Taxes</i>	16
Tax Rates on Wages in Michigan	17
<i>Tax Rates on \$1,000 of Wage Income in Michigan</i>	17
Illustrations: Total Tax Rates on Wages	18
<i>Total Tax Rates on Wage Income</i>	19
<i>Composition of Taxes: Payroll and Income</i>	20
Options for Tax Reform	21
Cutting Tax Rates	21
Increasing Exemptions	21

<i>Nontaxable Earnings Under Income & Payroll Taxes, 2002</i>	22
“Targeted Tax Cuts”	22
“Specific Tax Credits”	22
Raising the Tax Exemption	23
Conclusion: Other Alternatives	24
The Economic Growth and Tax Relief Act 2001	24
Considerations for Designing a State EITC	25
Simplicity	25
Connection with the Federal EITC	25
Refundable Tax Credit	26
<i>Income Taxed by Michigan Only</i>	27
States with Similar Programs	28
<i>State Earned Income Tax Credits Based on the Federal EITC,</i> <i>Tax Year 2001</i>	28
Likely Revenue Impact of A Michigan EITC	28
Anderson Economic Group Analysis	29
<i>Gross and Net Costs of 10% and 25% Michigan State EITC</i>	30
<i>Gross and Net Costs of a 25% Michigan State EITC</i>	31
Center for Budget and Policy Priorities’ Analysis	32
Other Michigan Analyses	32
Work Effort and the EITC	33
Research Findings	33
Other Policy Analyses	34
Problems With a State EITC	36
The Federal EITC Structure	36
The Error Problem	36
Conclusion: The Error Problem	38
The Welfare Critique	38
Comparison with Other Government Programs	39
Conclusion: The Welfare Critique	39
Appendix: Fiscal Estimation Model for a State EITC	40
<i>Assumptions in Michigan Fiscal Simulation</i>	40
<i>EITC Fiscal Estimation Model</i>	41

Transmittal Letter



August 01, 2002

Dear Michigan Citizen:

Last year over a half-million Michigan households received an Earned Income Tax Credit (EITC) as a result of their federal income tax filing. The EITC is a federal refundable tax credit designed to offset the payroll taxes of low and moderate-income workers. It was first initiated in 1975 and has enjoyed strong bipartisan support at the federal level.

The EITC provides significant tax relief to workers, primarily those with families who do not otherwise earn enough after taxes to raise their family above the poverty level. Indeed, the federal EITC lifts more children out of poverty than any other federal program.

A growing number of states are also enacting EITCs as a way to offer tax relief to low and moderate-income families, especially families struggling to make their way into the world of work for the first time. Eleven states now offer an EITC and, since 1997, seven states have enacted new EITCs or have expanded existing EITCs.

The Michigan Catholic Conference has advocated a Michigan EITC for several years. We are pleased that Patrick L. Anderson has written this report, providing policymaker and opinion leaders with the necessary data and analysis on a State of Michigan EITC. We hope this report serves as a valuable resource as this important issue continues to be deliberated. Given its findings, we are more convinced than ever that a Michigan EITC would be good public policy for the people of Michigan.

Sister Monica Kostielney, R.S.M.
President and CEO
Michigan Catholic Conference

ABOUT THE MICHIGAN CATHOLIC CONFERENCE

Founded in 1963, the Michigan Catholic Conference serves as the official voice of the Catholic Church in Michigan on matters of public policy. Through the Michigan Catholic Conference, the official Catholic position on public policy matters is presented with one voice to the legislative and executive branches of state government. In cooperation and coordination with parish and educative and human service agencies, diocesan offices, and other religious and non-sectarian associations, the Michigan Catholic Conference explores solutions to pressing social problems.

Guided by the biblical imperative for a commitment to justice, the Michigan Catholic Conference advocates on such wide-ranging matters as education, health care, abortion, capital punishment, assisted suicide, immigration and economics.

Issues are viewed in light of their effect on the well-being of all persons, the significance of their impact on public policy, and their implications for the Catholic community.

For more information on the Michigan Catholic Conference, we invite you to visit our web site at <http://www.micatholicconference.org>, or contact your local Catholic Church.

ABOUT THE AUTHOR

This report was authored by Patrick L. Anderson. Mr. Anderson is the principal of Anderson Economic Group, LLC, a consulting group serving the public and private sectors.

Mr. Anderson is a former Michigan state deputy budget director and chief of staff of the Michigan department of state, who has also held executive positions with two of the state's largest financial institutions. He is the author of over 85 articles and monographs on tax, finance, and public policy.

Ian Clemens and Ilhan Geckil, consultants with Anderson Economic Group, prepared the computer routines used to project the impact of local, state, and federal taxes on workers of different income. Research assistance, document preparation, and updating for 2001 and 2002 tax law changes were provided by Chistine LeNet.

Anderson Economic Group provides economic, public policy, and market analysis to commercial, government, and nonprofit organizations in Michigan and other states. The firm maintains a web site with extensive information at <http://www.AndersonEconomicGroup.com>.

Executive Summary

Over the past two decades, Americans have reached a consensus on eliminating the barriers that stand in the way of working individuals climbing out of poverty. This consensus has been expressed in a number of policy changes that would have seemed impossible in the 1970s: the historic federal tax reform in the 1980s, which reduced marginal rates and eliminated federal income taxes levied on millions of low-income workers; welfare reform in the 1990s, which changed the fundamental paradigm of welfare that had trapped far too many individuals in a cycle of dependency; and a growing number of smaller experiments that support, through education, training, daycare assistance, transportation, and other needs, the path of a struggling person into the working world, and from there toward the American dream.

PAYROLL TAXES: THE PUNISHMENT OF THE WORKER

Unfortunately, while we have eliminated the most obvious barriers towards working out of poverty, we have inadvertently increased other barriers. These notably take the form of extremely high payroll taxes. These payroll taxes—including unemployment insurance, federal unemployment taxes, OASDI taxes on both the employee and the employer, and Medicare taxes—provide a punishing disincentive to working for those who are trying to climb the ladder into the middle class. Because the effects of these taxes are largely unexamined, many people are unaware of the negative effects they have on workers. Figure 1, “The Workers’ Share of Labor Costs,” on page 7, shows how a single worker making just \$20,000 per year receives only 76% of the labor costs incurred by his or her employer.¹

The size of the burden is striking—and the largest share of that burden is payroll taxes, not income taxes. Total payroll taxes on a worker earning just \$1000 per year in Michigan often exceed 20.1%. Workers earning above \$84,900 per year, however, have a payroll tax burden that drops to 2.9%. While high-income workers pay extremely high federal income tax rates, it is difficult to justify payroll taxes that are *seven times* higher for low-income workers as for high-income workers.

THE EARNED INCOME TAX CREDIT

One powerful way of addressing these punishing disincentives is through an earned income tax credit (EITC). An EITC is exactly that: a *credit for income earned*, which is available to workers at the lower end of the income scale. An EITC offsets most or all of the payroll taxes borne by a worker earning a wage around the poverty level, and then phases out as their income increases.

1. We assume in the calculations that the worker pays nonresident city income tax. Note that the labor costs include payroll taxes paid by the employer, in addition to gross wages.

FIGURE 1. The Workers' Share of Labor Costs

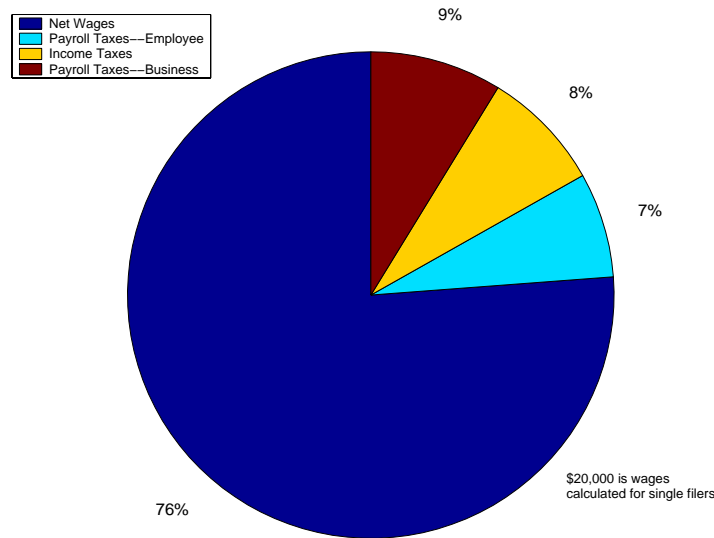

Source: Anderson Economic Group LLC
 Base Data: 2002 U.S. Master Tax Guide, CCH, Inc.
 Generated on 06/07/2002

Thus, the EITC is a pro-work, pro-family measure. It provides no benefit to an individual who chooses not to work—but a big boost for someone who, of their own initiative, goes out to work. Many states are now considering increasing the incentives to work through the federal EITC, by adding on a state EITC. This state EITC can offset some of the disincentives to work created by state and local payroll taxes, as well as state and local income taxes. As President Ronald Reagan, who signed into law an EITC expansion in 1986, once stated, the EITC is “the best anti-poverty, the best pro-family, the best job-creation measure to come out of Congress.”²

A MICHIGAN EITC

Our analysis shows how a Michigan earned income tax credit would dramatically reduce the burden of payroll and income taxes on those workers earning \$10,000 per year or less, and also provide assistance to adults who are trying to work and care for children. Through the use of federal and state earned income tax credits, the effective tax rates on the first \$10,000 for a single mother caring for two children can be brought down to zero. Letting her keep her earnings—rather than face effective tax rates that start above 20%—would strongly encourage work and family independence.

2. “Sweeping Tax Overhaul Now the Law,” *Chicago Tribune*, October 23, 1986; cited in Nicholas Johnson, *A Hand Up*, Washington DC, Center for Budget and Policy Priorities, 1999, p. 3.

Our analysis shows that the gross costs of a Michigan earned income credit equal to 25% of the federal credit would be approximately \$213 million. However, the *net cost*—after taking into account the other state taxes these workers would pay, as well as reduced social spending—would be much lower, about \$82 million. Such a credit would likely induce another 68,700 residents of this state to enter the workforce.³ While the jobs available to these workers would be initially lower-wage or part-time work, working in some capacity would be an important step for individuals and their families.

CONCLUSIONS & RECOMMENDATIONS

CONCLUSIONS

- Getting people out of poverty should be a major goal of tax policy. The Reagan-era reforms eliminated many low-income workers from federal tax liability. However, payroll taxes remain a huge problem. For most workers earning \$32,250 or less per year, payroll taxes—not income taxes—are the dominant tax burden.
- Current tax policy punishes lower-income workers. Even Michigan workers earning between \$5,000 and \$20,000 face payroll tax burdens of approximately 20%. By contrast, payroll tax burdens on workers earning above \$84,900 per year drop to 2.9%. While these workers pay very high federal income tax rates, it is difficult to defend payroll tax burdens that are *seven times* as high for low-income workers.
- The Federal EITC effectively encourages work and increases after-tax earnings for low-income workers, by returning to them much of the payroll taxes they otherwise shoulder. A Michigan EITC would increase the effectiveness of the federal credit within our state, further encouraging work and increasing after-tax income.
- The gross costs of a Michigan earned income credit equal to 25% of the federal credit would be approximately \$213 million. However, the net cost—after taking into account the other state taxes these workers would pay, as well as reduced social spending—would actually be much lower, about \$82 million. Such a credit would likely induce another 68,700 residents of this state to enter the workforce.
- The gross cost of a Michigan EITC set at a lower 10% share of the federal EITC would be less than \$80 million, and the net cost would be \$27 million.
- The IRS estimated a significant error rate for the EITC applicants in the 1990s. This error rate is not surprising given the complexity of the rules used by the IRS to establish eligibility, and does not mean that a large share of EITC filers commit “fraud,” as is sometimes claimed. The subsequent efforts to improve training, simplify eligibility, and increase enforcement have brought the IRS-estimated error rate down to less than 7%. We concur with the IRS Taxpayer Advocate in encouraging Congress and the IRS to continue efforts to simplify the EITC.

3. An increase of 68,700 new workers would represent approximately 1.3% of Michigan’s civilian labor force of 5.1 million.

RECOMMENDATIONS

- Michigan should strongly consider joining the other states that have adopted state earned income tax credits based on the federal EITC. Such a credit could easily piggyback on the federal EITC, reducing compliance costs.
- While such a state earned income tax credit would reduce income tax revenue, the resulting increase in other taxes, along with reductions in social spending, would likely offset more than half the loss in income tax revenue.
- The state should also consider increasing the personal exemption for the Michigan income tax. At \$3000 per person, it is woefully inadequate at excluding from taxation the income needed to cover basic living costs.
- The state should work with the federal government on simplifying the complex eligibility rules for the EITC.

Income and Payroll Taxes

FEDERAL INCOME TAXES

Income taxes are very well known. Debates about marginal tax rates and the distribution of the burden are a permanent fixture in national politics. Thus, most working individuals are quite well aware of the “progressive” structure of the federal income tax, which requires an increasing tax burden as wages grow.

For federal income taxes, the historic Reagan-era reforms, although subsequently modified, achieved an important goal of eliminating millions of lower-earning taxpayers from federal income tax liability.

The Federal Revenue Code establishes personal exemptions and standard deductions that allow a certain amount of income to be earned without tax liability. These amounts are indexed annually for inflation.

The 2002 personal exemption of \$3,000, plus the standard deduction of \$4,700 for a single person, makes the first \$7,700 of earnings tax-free for a single person.⁴ A married couple with one child pays no federal income taxes on the first \$16,850 of earnings above that threshold amount, taxpayers pay marginal rates of 10%, 15%, 27%, 30%, 35%, and 38.6%, as their income rises.⁵ For example, in 2002 married individuals filing jointly will pay no federal income tax on the initial exemption and standard deduction amounts, and then tax at 10% on the first \$12,000 in taxable income; single individuals will pay tax at 10% on taxable income of up to \$6,000.

STATE AND LOCAL INCOME TAXES

Many states and cities also levy income taxes. In Michigan, taxpayers face a flat-rate state income tax of 4.1% in 2002.⁶ Many cities also levy an income tax on wages earned within the city of 1%, with nonresidents paying half that amount. Some cities levy higher or lower rates. The City of Detroit, through a special allowance in state law, levies a much larger rate, which is currently 2.65%, but is scheduled to decline over the next decade.⁷

4. Amounts shown for 2002 were estimated by Commerce Clearing House of Chicago, Illinois as of November 2001; See *2002 Master Tax Guide*. Paragraph 127

5. Readers are cautioned that actual tax returns, especially federal income tax returns, are much more complicated, and may have actual marginal rates that are greatly distorted by the existence of alternative minimum taxes (AMT), phase-outs of exemptions and deductions, loss carry forwards, and other fiendishly complicated aspects of the Internal Revenue Code.

However, for the individuals of most concern in this report—those earning less than about \$30,000 per year—these aspects of the Internal Revenue Code are, in the vast majority of cases, not a major concern. Payroll taxes, on the other hand, definitely are.

6. Public Act 6 of 1999 requires the state income tax to be reduced in 2002 to 4.1%.

7. Public Act 500 of 1998 specifies a declining rate structure, although it allows for certain conditions under which the City could retain higher rates. The decline in rates began in July 1999. For more information see the Citizens Research Council organization web site at www.crcmich.org.

Taxable income for the state is based on federal adjusted gross income (AGI), which is calculated before deductions and exemptions. With the state personal exemption at only \$3,000 and no deductions, almost every dollar of wage earnings is taxed in Michigan.

OASDI (SOCIAL SECURITY AND MEDICARE) TAXES

The formal name for Social Security taxes is old age, survivors, and disability insurance (OASDI). Both employees and employers must withhold 6.2% of wages for the “Social Security” portion of the tax, and an additional 1.45% for the “Medicare” portion of the tax.

When combined, this payroll tax burden is 15.3% of wages, up to the phase-out amount for the Social Security portion of the wage base, which is \$84,900 in 2002. There is no phase-out amount for the Medicare portion of this payroll tax.

FUTA (FEDERAL UNEMPLOYMENT TAX ACT)

The federal government also imposes a 6.2% federal unemployment tax assessment on wages, up to a phase-out amount. However, most states (including Michigan) have their own unemployment insurance systems, and for these states a substantial credit is offered that reduces the net tax to 0.8%.

This tax is subject to a phase-out at \$7,000 in wages, per employee.

UNEMPLOYMENT INSURANCE

The State of Michigan requires employers—even households—to pay unemployment insurance taxes. For new employers, the rate has been 2.7% for several years. Large employers, and employers with several years of experience, pay a rate partially based on their own unemployment benefit experience, which could be higher or lower. Construction workers, for example, are charged at an initial rate of 8%. The average rate across the state has ranged from 4.5% to 2.7% over the past ten years.⁸

This tax is subject to a phase-out at \$9,500 in wages, per employee, in the State of Michigan. The phase-out limit will decrease to \$9,000 in 2003, due to the passage of Public Act 192 of 2002. The same Act increased benefits immediately, with the maximum benefit increasing from \$300 per week to \$362.⁹ It is likely that the net effect of these changes will be to increase the average unemployment insurance tax rate in the future.¹⁰

WHO PAYS PAYROLL TAXES?

It is clear that income taxes are borne by employees, as the tax is withheld from their paychecks, and the employees file annual returns. However, many employ-

8. State of Michigan Bureau of Workers' and Unemployment Compensation web site at: <http://www.michigan.gov/bwuc>, table “Average Contribution Rate Based on Total and Taxable Payrolls, 1936-2000.”

9. See fact sheets 97 and 98, available on the State of Michigan Bureau of Workers' and Unemployment Compensation web site at: <http://www.michigan.gov/bwuc>.

10. Because the tax rate is set by calculating the tax revenue necessary to pay benefits, increasing the benefits has the effect of increasing the rate. However, the rate is adjusted over time, so the full effect of PA 192 of 2002 will not be felt for several years.

ees—and even managers—are unaware of the number of payroll taxes and the burden they place on employees.

Social Security taxes are an example. Although half of this tax appears to be charged to employers, in reality the worker bears the entire cost of such payroll taxes. When a worker is hired, the employer makes an economic decision on the product the worker provides—his or her output of goods and services—is worth more than the cost of employing the worker. The cost of employing that worker includes his gross wages, and any payroll taxes. If this total cost is more than the output of the worker, the company will lay off the worker, or eventually go out of business.

From economic reasoning alone, it is clear that the worker must bear the burden of producing enough goods and services to pay for his or her wages, plus all payroll taxes. Past studies that have attempted to disentangle statistically the share of burden that falls on employees have commonly found at least 70% of the payroll tax burden borne by workers.¹¹ However, even this understates the degree to which employees actually bear the burden.¹² There is a broad consensus among economists today that workers—not employers—shoulder the burden of payroll taxes.¹³

This economic reasoning is illustrated by two easy-to-grasp examples: the household employing a child-care or domestic help worker, and the self-employed worker.

EXAMPLE: TAXES ON THE HOUSEHOLD WORKER

Consider first the family that hires a part-time worker to help with child-care or domestic work, and agrees to pay \$7 per hour gross wages. In fact, the cost to the family is \$7 per hour, plus an additional 6.2% for social security, plus an additional 1.45% for Medicare, plus 2.7% for state unemployment insurance, plus 0.8% for FUTA—for a total cost of \$7.81 per hour.

If the family cannot afford \$7.81 per hour, it can't hire the worker. If the family doesn't believe that the services are worth \$7.81 per hour, it won't hire the worker. The decision revolves around the total cost—not the stated wage.

11. See, for example, Anderson and Meyer, "The Effects of Firm Specific Taxes..." *Journal of Public Economics*, August 1997; and Gruber and Krueger, "The Incidence of Mandated Employer-Provided Insurance..." *Tax Policy and Economy* (1991); cited in Wilson, "How Congress Can Lower Federal Taxes on American Jobs," Heritage Foundation *Backgrounder* no. 1287, May 27, 1999.

12. Employees also benefit from the profitability of a company, so lost employer earnings results indirectly in lost wages. However, for the purposes of this study, the difference between the employee bearing 70% and 100% of the payroll tax burden is not material.

13. As a further example, liberal economist Paul Krugman writes in his most recent book, "Again, there is generally universal agreement that the real burden of the [payroll] tax falls almost entirely on the worker. Basically, an employer will only hire a worker if the cost to the employer of hiring that worker is not more than the value that worker can add." Krugman, *Fuzzy Math*, New York, Norton, 2001; page 43. [Emphasis in original.]

Thus, it is the worker's burden to produce goods and services of sufficient value to meet the \$7.81 per hour threshold—with the penalty for failure being the loss of the job. Who, then, really pays those payroll taxes? It should be clear that they come from the worker's production of goods and services, whether the government ostensibly collects them from the employee or the employer.¹⁴

EXAMPLE: TAXES ON THE SELF-EMPLOYED

The fact that employees fundamentally bear the cost of payroll taxes is borne out clearly for self-employed individuals. The self-employed are subject to a 15.3% tax on net earnings, composed of a 12.4% OASDI tax, and a 2.9% Medicare tax.¹⁵

WHO BENEFITS FROM PAYROLL TAXES?

One aspect of payroll taxes that partially justifies their existence is the stream of benefits they provide. Unemployment insurance taxes, for example, do purchase some benefit in the form of unemployment benefits. However, as every baby boomer knows, payroll taxes in general do not have a direct benefit for the worker who pays them. Social Security and Medicare taxes, for example, are direct tax payments into a pay-as-you-go system. Taxes paid today by one worker have no direct relationship with that worker's benefits.¹⁶ Furthermore, a political process, not any actuarial calculation, largely sets benefits.¹⁷ Finally, payroll taxes such as FUTA, Medicare, and even Social Security have a direct connection with general government revenues, and only an indirect connection with individual benefits.¹⁸

Thus, while payroll taxes do purchase some benefit, that benefit is generally only tangentially related to the worker at hand, who does not have a choice about paying for the promised benefit.

14. For most workers, all their income and payroll taxes are collected directly from their employer, who is compelled to withhold income and payroll taxes from his or her gross wages, and to withhold additional payroll taxes as well. These amounts never touch the worker's hands, and are transmitted to the federal and state governments on a regular basis—sometimes as often as weekly. The only distinction then is how the paycheck describes the taxes.

Some employers, such as the State of Michigan, have begun to report payroll taxes and other burdens to workers along with their paychecks. The Mackinac Center for Public Policy's *Right To Know Payroll Form* motivated a number of employers to provide this improved disclosure. See <http://www.mackinac.org>.

15. In recent years, a credit has been available to some taxpayers to offset a portion of these taxes.

16. There is, of course, an *indirect* relationship. The degree to which a person works and earns money does affect their eligibility for benefits.

17. This can be observed by watching the ubiquitous “save Social Security” ads during any election year—even in state elections during which candidates have no chance of affecting social security policy!

A second reminder is the degree to which Social Security appears to suffer periodic “crises,” which must be “solved” after a national commission researches the evidence and discovers the obvious solution. Both the 1980's and 1990's brought such crises. In fact, the system has a regular actuarial report, which regularly reports on the quite-apparent condition of the system.

**SUMMARY OF PAYROLL
AND INCOME TAXES**

Table 1, “Income and Payroll Taxes in the State of Michigan, 2002,” on page 15 summarizes the rates and phase-out levels, if any, of payroll and income taxes. Note how, as income rises, the federal income tax burden increases progressively. Compare that with payroll taxes, which generally apply to the first dollar of earnings, and then phase out as income rises.

Figure 2, “Effective Tax Rates, Selected Income & Payroll Taxes,” on page 16 graphically represents four groups of taxes, and their impact on wages to a married couple with one child, earning from \$1,000 per year to \$100,000.¹⁹

18. This is made clear by noting three facts: First, surpluses in these “trust funds” are invested in US Treasury securities, which directly support government spending; second, many measures of the government budget include trust fund surpluses when calculating the overall budget deficit or surplus; and third, Congress has often extended these taxes even when the ostensible purpose has been fulfilled, using the excess to support spending in other areas.

On this last point, for FUTA taxes, see Wilson, “How Congress Can Lower Federal Taxes on American Jobs,” Heritage Foundation *Backgrounder* no. 1287, May 27, 1999, which notes how the “temporary” 0.2% FUTA surtax has been extended by Congress through 2007, even though the balance in the federal UI trust fund ballooned to over \$23 billion by 1998. Wilson calculates the effect on Michigan workers of ending the *surtax alone* at \$298 million over the years 2000-2004.

19. In this graph, the “effective tax rate” is the tax burden at any income level, divided by that income. This burden/base ratio is sometimes called the “average rate.” The marginal rate, in contrast, is the rate applied to the next dollar of earnings.

TABLE 1. Income and Payroll Taxes in the State of Michigan, 2002

Tax	Detail	Rates
Federal Income Tax	Progressive rate structure, which varies with filing status; gross income is reduced by exemptions and a standard deduction.	10% to 38.6%
State Income Tax	The first \$16,850 is not taxable for a married couple with one child, (\$7,700 for a single individual). ^a Michigan has a flat-rate tax with few modifications; the personal exemption amount is \$3,000; there are no standard deductions.	4.1% ^b
Local City Income Taxes	Twenty-two Michigan cities impose a tax on residents and nonresidents working in the city, and most cities allow the minimum exemption amount of \$600. ^c	Most at 1% for residents and half that for nonresidents. Detroit rates are 2.65% for residents and half that for nonresidents. ^d
OASDI (“Social Security”)	Phase-out at \$84,900.	12.4% collected half from employees and half from employers.
Medicare	No phase-out.	2.9% collected half from employees and half from employers.
Unemployment Insurance	Phase-out at \$9,500. ^e	2.7% for new employers; many employers higher; some lower. The average has been about 3.5%. ^f
FUTA	Phase-out at \$7,000.	0.8% with state credits; otherwise 6.2%.

Sources: AEG; Commerce Clearing House; IRS; Michigan Department of Treasury; Michigan Unemployment Agency; Citizens Research Council of Michigan.

- a. Non-taxable amounts are the sum of the standard deduction and the total exemptions claimed. These are indexed and change each year. For 2002, the exempt amount is estimated to be \$3,000, and the standard deduction to be \$4,700 for a single taxpayer and \$7,850 for a couple filing jointly.
- b. The Michigan income tax rate was 4.2% in 2000 and 2001; Public Act 6 of 1999 requires the 2002 Michigan income tax rate to drop to 4.1%.
- c. Public Act 284 of 1964, section 141.631, states that a city must allow a minimum exemption of \$600. Most cities, including Lansing, have a \$600 exemption amount. However, a few cities (including Detroit at \$750) allow higher exemptions. We assume a \$600 exemption in our analysis.
- d. The general city income tax rate is 1% for residents and 1/2% for nonresidents, with an allowance for cities to levy a lower rate; see section 11 of the City Income Tax Act.
Some cities (Highland Park, Grand Rapids, and Saginaw) are allowed to levy rates of up to 2% on residents. In addition, Section 3 of the Act provides for a city with a population in excess of 750,000 (Detroit) to levy income taxes at up to 2.7% for residents. Under PA 500 of 1998, Detroit’s rates are required to decline over time to 2%. Under the required rate reduction schedule, the effective rate for 2002 is 2.65% for residents and half that for nonresidents. See Citizens Research Council, “Outline of the Michigan Tax System,” found at www.crcmich.org.
- e. The phase-out amount will decrease to \$9,000 in 2003, under Public Act 192 of 2002.
- f. See State of Michigan, Bureau of Workers’ & Unemployment Compensation web site (Statistics section); table “Average Contribution Rate Based on Total and Taxable Payrolls, 1936-2000.”

FIGURE 2. Effective Tax Rates, Selected Income & Payroll Taxes

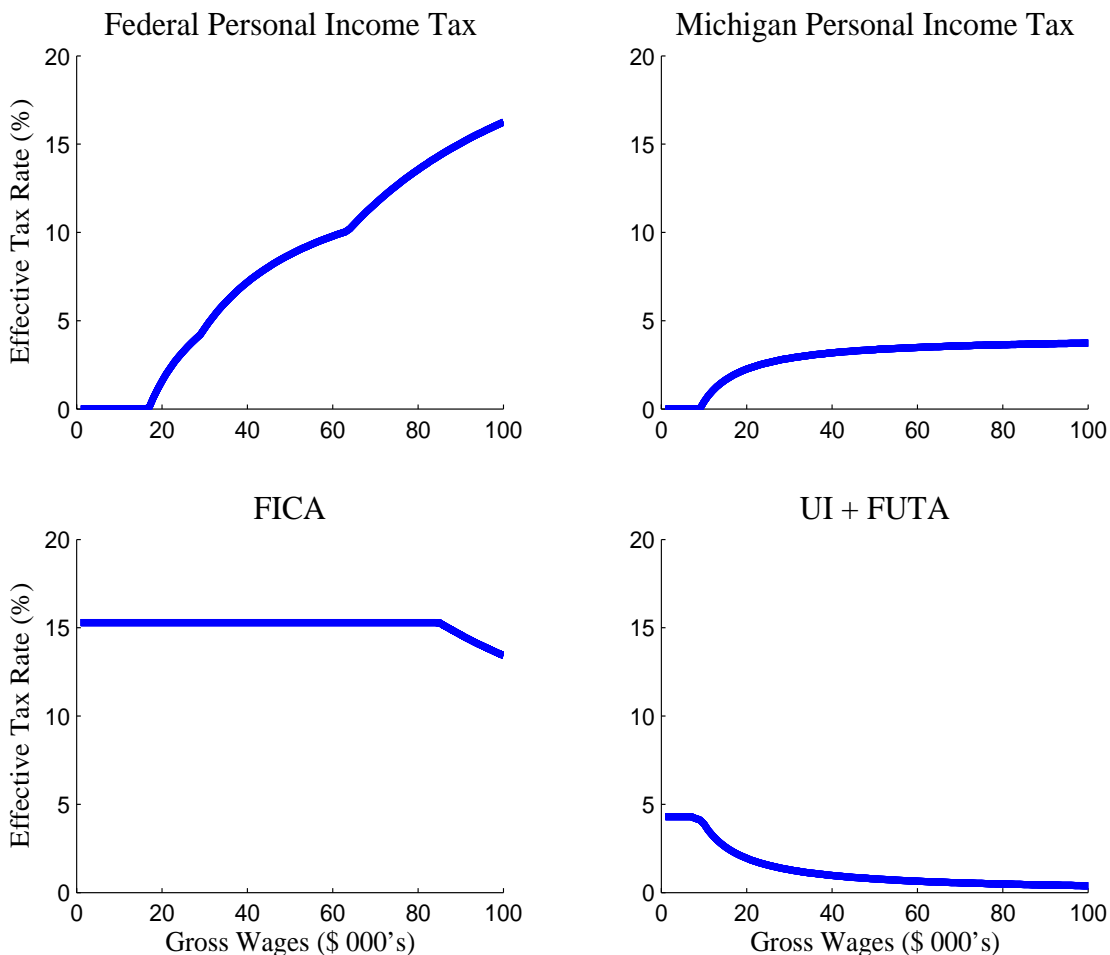

Source: Anderson Economic Group

Generated on 31-Oct-2002

TAX RATES ON WAGES IN MICHIGAN

The total tax burden on wages of a certain amount earned in the State of Michigan varies depending on the location of employment, the residence of the worker, and the employer. While Federal and State income tax rates (and Social Security tax rates) are the same in all locations and industries, the unemployment insurance tax and city income tax rates vary considerably.

For example, consider 3 employees, all single:

1. Employee 1 lives and works in Detroit, for a construction company. Such an employee would probably face a total tax burden on the first \$1,000 of wages of approximately 27%, given the high resident income tax and unemployment insurance rates that would apply.
2. Employee 2 lives outside a medium-sized city, and works for an employer within the city with an average unemployment insurance tax rate. Her total tax burden would be about 20%.
3. Employee 3 lives and works in a rural area and works for an employer who rarely has unemployment insurance claims. His total tax burden on the first \$1,000 of wages is approximately 17%.

In the tax analyses in this report, we typically assume a taxpayer facing nonresident income taxes and a typical unemployment insurance rate, such as Employee 2 in this example. However, the range of payroll tax rates in Michigan, at just \$1,000 of wage income, is surprising in both the large range and the high level. Table 2, “Tax Rates on \$1,000 of Wage Income in Michigan” shows the breakdown of income and payroll taxes for the example workers.

TABLE 2. Tax Rates on \$1,000 of Wage Income in Michigan

	Employee 1	Employee 2	Employee 3
Income Taxes			
Federal Income Taxes	0.00%	0.00%	0.00%
Michigan Income Taxes	0.00%	0.00%	0.00%
City Income Taxes	2.65%	0.50%	0.00%
Payroll Taxes			
OASDI (employer)	6.20%	6.20%	6.20%
OASDI (employee)	6.20%	6.20%	6.20%
Medicare (employer)	1.45%	1.45%	1.45%
Medicare (employee)	1.45%	1.45%	1.45%
FUTA	0.80%	0.80%	0.80%
UI	8.10%	3.50%	1.00%
<i>Total Tax Burden</i>	<i>26.85%</i>	<i>20.10%</i>	<i>17.10%</i>

**ILLUSTRATIONS: TOTAL
TAX RATES ON WAGES**

To illustrate the effects of income and payroll taxes, we created a simulation model that calculates tax liabilities depending on gross wages.²⁰ The model incorporates exemptions, the standard deduction, and tax rates, but does not include itemized deductions, special credits, or the alternative minimum tax.²¹

We used this model to calculate total taxes paid, including both income and payroll taxes, on workers at various income levels. We also included the effects of the federal EITC, for those workers that qualify.

Figure 3, “Total Tax Rates on Wage Income,” on page 19 illustrates this analysis.

In the top panel of the figure, we total up the income and payroll tax burdens on a single mother with one child in her care. We assume she lives in Michigan, and pays nonresident city income tax at the median rate of 0.5%.²²

The mother is burdened with an effective tax rate of approximately 20% on her first \$1000 to \$6,000 of earnings. These taxes are almost entirely payroll taxes, with some Michigan city and state income taxes paid. However, she pays no federal income tax.

Her tax burden rises to approximately 26% of wages once she makes \$22,000 per year. At that point the Michigan and federal unemployment taxes have phased out, social security taxes are still levied, and federal income tax liability becomes a factor.

At earnings of \$84,900 or more federal income taxes are levied at a high rate, but the social security tax is phased out. Thus, should the mother gain the fortunate position of earning \$90,000 per year, her tax burden would jump to nearly 40%, most of which would be federal income tax.

The bottom panel shows the same mother, with the federal EITC. At low earning levels—below \$10,000 per year—the EITC offsets her payroll and income taxes. As noted above, at this income level, almost all taxes paid on earnings are payroll taxes. At higher earnings, there is no difference in the tax burden, as the EITC phases out with earnings above about \$20,000.²³

20. The model uses certain simplifying assumptions about federal income taxes. We also assumed that wage and salary earnings are the dominant form of income for the taxpayer. This will be an accurate reflection of most taxpayers with earnings of \$100,000 or less, and almost all working taxpayers with earnings under \$25,000.

21. While the model accurately projects the approximate tax burden on wage and salary income at various earning levels, it is not intended to calculate the specific taxes of any individual taxpayer.

22. If she were a resident of a city that levied an income tax, she would pay double the non-resident rate.

23. For a mother with two children, the credit phases out at a higher level; for those with no children, it phases out a lower amount of earned income.

FIGURE 3. Total Tax Rates on Wage Income

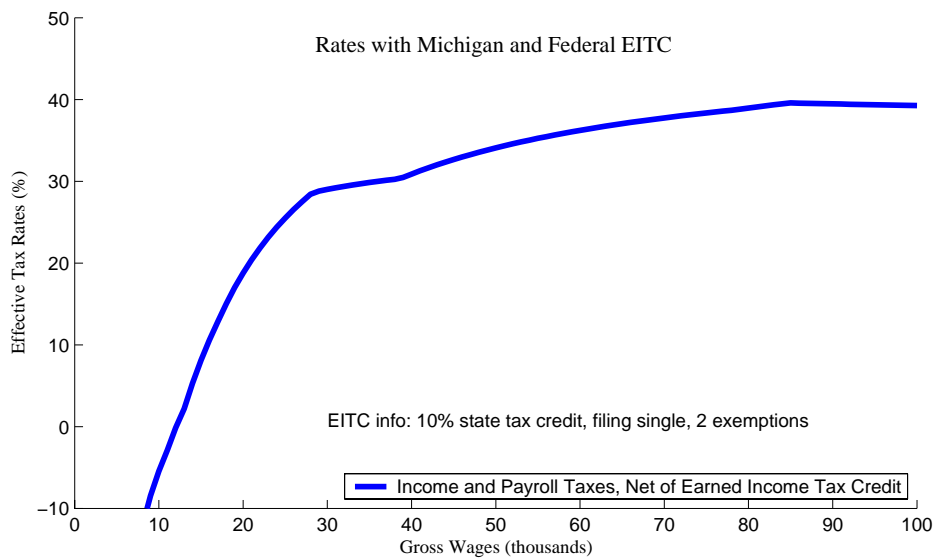
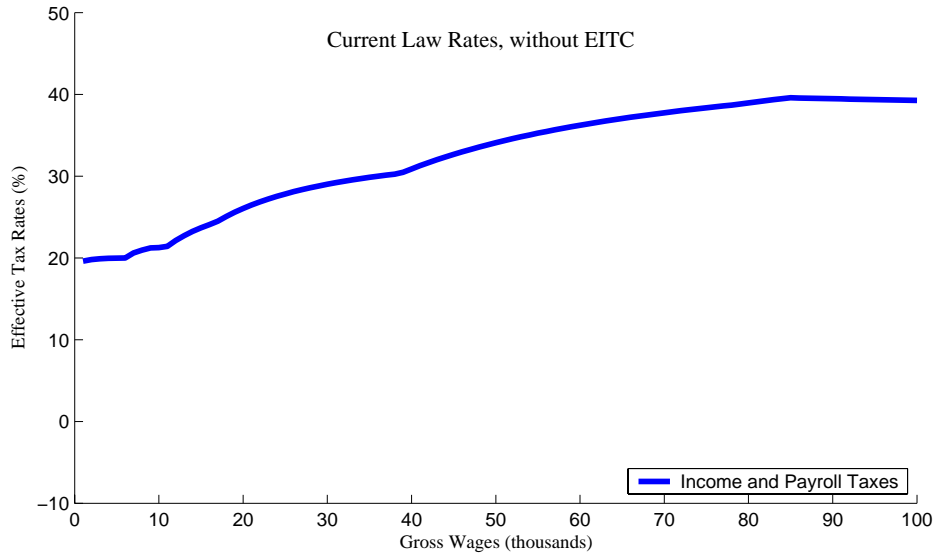

Source: Anderson Economic Group

Generated on 31-Oct-2002

Figure 4, “Composition of Taxes: Payroll and Income”, shows the portion of tax burden due to payroll and income taxes. As the figure shows, for typical Michigan workers earning about \$32,250 or less, payroll taxes exceeded their total federal, state, and local income taxes.

FIGURE 4. Composition of Taxes: Payroll and Income

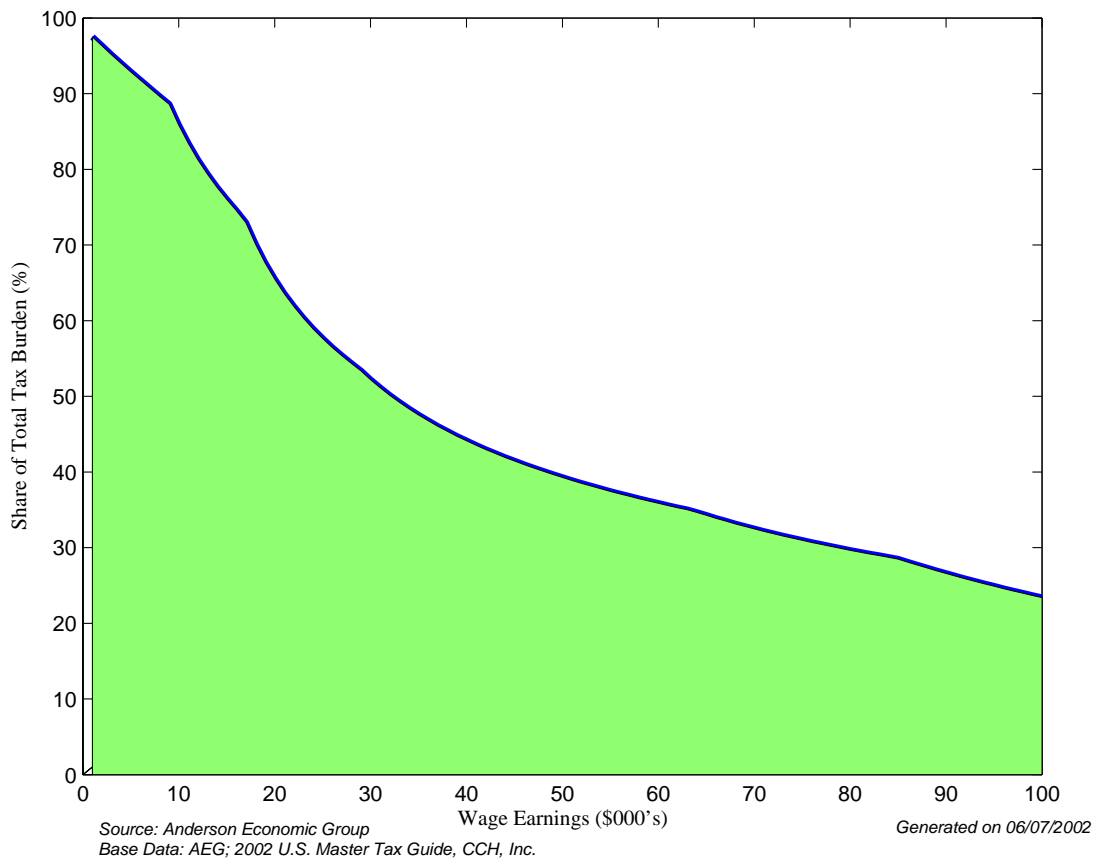

Options for Tax Reform

To address the problem of high payroll taxes and the resulting disincentive to work, the EITC is a powerful option. However, it is not the only option. This section briefly discusses the alternatives policy makers face.

CUTTING TAX RATES

Cutting tax rates is an attractive option, in that it reduces the disincentives to work at all levels. Clearly, the historic Reagan-era reforms dramatically reduced the income tax burden on working individuals, as well as ushered in tremendous incentives to expand the economy. Further reduction in tax rates, whether they are at the state, federal, or local level, would also stimulate job opportunities for those entering the workforce or with lower skill levels.

INCREASING EXEMPTIONS

One of the beneficial effects of the Reagan-era reforms was to eliminate lower-income tax payers from any federal income tax liability, by increasing the amounts of income exempt from tax, and by indexing the exemptions for inflation. In 2002, the personal exemption of \$3,000 and standard deduction of \$4,700 make the first \$7,700 of income nontaxable to single filers.²⁴ Married individuals filing jointly and with one child pay no tax on the first \$16,850 of income.²⁵

These amounts are indexed for inflation, and the 2002 amounts included here are estimates.²⁶

Table 3, “Nontaxable Earnings Under Income & Payroll Taxes, 2002,” on page 22, outlines the amount of income that a taxpayer can earn without paying income or payroll taxes.²⁷ Note how, for many low-income individuals, the federal income tax is the lowest burden they shoulder. These individuals face punishing disincentives from payroll taxes, not federal income taxes. The EITC is a way, through a credit against income taxes, for these payroll taxes to be offset.

24. In a perverse twist, these exemptions are phased out for high income taxpayers.

25. For married couples with one child, the combination of three exemptions (3 x \$3,000 = \$9,000) and a standard deduction (for married couples, \$7,850) make the first \$16,850 nontaxable.

26. The estimates are from the *2002 Master Tax Guide*, Chicago, IL, CCH; paragraphs 126, 135-6.

27. These are not the same as filing thresholds, which allow some workers that may otherwise owe taxes to avoid sending in *de minimis* amounts. Even with filing thresholds, such as on unemployment taxes, those that file must count every single dollar earned.

TABLE 3. Nontaxable Earnings Under Income & Payroll Taxes, 2002

Tax	Nontaxable Earnings, Single Taxpayer	Nontaxable Earnings, Married Couple with One Child
<i>Income Taxes</i>		
Michigan Income Taxes	\$3,000	\$9,000
Michigan City Income Taxes	\$600	\$1,800
Federal Income Taxes	\$7,700	\$16,850
<i>Payroll Taxes</i>		
Social Security OASDI	0	0
Medicare	0	0
UI	0	0
FUTA	0	0
<i>Source: AEG; IRS; State of Michigan</i>		

“TARGETED TAX CUTS”

The term “targeted tax cuts” is a euphemism for selecting specific individuals or groups for reduction in taxes. As one of the cardinal principles of taxation is *uniformity*—similarly situated taxpayers pay the same amount—any deviation from that principle is immediately suspect.²⁸ Of course, as the federal tax code is progressive—meaning that individuals at different income levels pay different marginal rates—it is not completely uniform for all taxpayers.

An EITC can be seen as “targeting” tax relief to those who need it the most. However, it is not targeting specific individuals, regions of the state, types of behavior (beyond working or having dependents), or other groups of people. Every similarly eligible person who works, and earns income at a certain level, and pays taxes on that income, receives a uniform amount.

“SPECIFIC TAX CREDITS”

Michigan in the past has adopted specific tax credits for the cost of heating homes, for property taxes, and for various other actions on the part of taxpayers.²⁹

There are two problems with specific tax credits. The first is that they violate the uniformity principal discussed above. If we wish people to contribute more to natu-

28. As with many economic principles, Adam Smith described it in *The Wealth of Nations*, first published on March 9, 1776. Smith established four “maxims of taxation,” the first of which was “equality.” *Wealth of Nations*, book V, ch. II, part II.

Our fundamental laws reinforce this notion. The Michigan Constitution requires that the property tax be uniform in Article IX, section 3, and further establishes a system of equalization to ensure uniformity. Other taxes are levied at prescribed uniform rates.

The US Constitution, in requiring “equal protection under the laws,” also restates this principle. The US Constitution prohibited an income tax until the last century.

29. These tax credits are not confined to the income tax; they are also available for the single business tax.

ral resource preservation, support causes that help children, give to homeless shelters, support community foundations, heat homes, and pay their property taxes (all of which receive some form of favored tax treatment under Michigan laws,) one effective way to do it would be to reduce taxes on all taxpayers. This report does not analyze the pros and cons of each individual tax preference, but it does note that a wide assortment of individual preferences for specific items has the effect of forcing marginal rates higher, as well as adding to complexity.

The second problem is that tax preferences of this type tend to encourage behavior in ways that is counter-productive to the public policy goal. For example, Michigan's extraordinarily large property tax credit system—especially before 1994—had the effect of encouraging high property taxes. It was common to see political campaigns supporting higher property tax rates argue that the higher property taxes would be offset by the Michigan “homestead” property tax credit. Similarly, the home heating credit encouraged individuals to avoid economizing on heating costs or insulating their homes, knowing that the tax code would support expenditures in that area.

The EITC does support an activity; namely work. We therefore anticipate that increasing the rewards for going to work, through the addition of a state EITC, would encourage more people to work. This is clearly a positive for the state, and does not have the negative effects that the wide array of specific tax incentives supporting specific expenditures would.

RAISING THE TAX EXEMPTION

Another option would be to increase the exemption for income taxes. As noted above, for federal income taxes, this would have some effect in the range of incomes we are discussing.³⁰ Because the state tax exemption is so small, an increase in this exemption would be a powerful change. Michigan policy makers should strongly consider increasing the personal exemption for the Michigan income tax. This exemption, currently set at \$3,000, does not come close to recognizing the true expense involved in adding a child to a family. Substantial increases in the exemption would reduce the disincentives to work for families, as well as reducing their tax burden and making the tax code more family-friendly.³¹

However, such policy action should be taken while also considering reducing income tax rates. Furthermore, we should recognize that Michigan's flat-rate

30. It would have very positive effects on families with children.

31. A recent Mackinac Center *Viewpoint* (“Which is better: cutting income tax rates or increasing the exemption?” no. 99-15, by Dean Stansel) argues that rate cuts are superior. However, perhaps hampered by length constraints, the author of that article incorrectly argues that increasing the exemption would not increase incentives to work. From the point of view of the example cited in the article—a family earning \$50,000 per year—that is almost true. Such a person already has a good-paying job, and the potential tax reduction from an exemption increase would be on the order of 5% to 10%.

However, from the point of view of a single mother with two children, who is struggling between working and not working, the difference in sheltering a paltry \$3000 per person in earnings and, say, \$4000, is substantial. Such a change would result, for a job earning just \$12,000 per year, in a tax reduction of 100%, and leave an extra \$123 in her pocket. That clearly is an improved incentive to work.

This observation doesn't change a central assertion of the *Viewpoint* article, namely that lowering tax rates increases the incentive for everyone to work.

income tax—at 4.1%—is a little more than one-quarter the payroll tax burden from social security, FUTA, Medicare, and unemployment insurance. For individuals earning \$25,000 or less, an earned income tax credit is a much more powerful incentive than a reduction in the Michigan income tax rate, and would work well with an increase in the exemption.

CONCLUSION: OTHER ALTERNATIVES

Some alternatives to a state EITC, notably overall reduction in tax rates and an increase in the state income tax exemption, would make the tax code more family friendly, and increase the incentives to work. They should be considered by the Michigan legislature.

However, for the specific problem we are addressing in this report—the punishing disincentives faced by those who earn \$25,000 or less—the EITC is the most powerful solution.

THE ECONOMIC GROWTH AND TAX RELIEF ACT 2001

The Economic Growth and Tax Relief Reconciliation Act of 2001 helped reduce the tax burden at the federal level for lower income families. This act affected families by reducing the EITC “marriage penalty,” lowering marginal tax rates, and increasing exemptions and child credits.³²

Marriage Penalty on EITC Recipients. The “marriage penalty” (the additional taxes paid by a married couple, above what they would have paid as single individuals taken together) was reduced for those couples using the EITC. Prior to the passage of this act, many married couples who had been eligible as single individuals for the tax credit, lost the credit as a result of their combined income exceeding the EITC phase-out limit. Under the new law the tax credit phase-out amount for married couples has been increased by \$1,000 in 2002 and will further increase by \$3,000 after 2007. The phase-out amount for single individuals is projected to be \$2,550 in 2002; hence the phase-out amount for married individuals would be \$3,550. This reduces the tax penalty born by lower-income married couples.³³

Marginal Rates. The Tax Relief Act of 2001 reduced all marginal tax rates, thereby decreasing the tax burden of working parents earning that pay federal income taxes. However, as noted above, most individuals eligible for the EITC already pay little or no federal income tax.

Increased Exemptions and Child Credits. The new law also increases the exemption and child credit amounts. As a result the federal tax code has become less onerous for those supporting children or other dependents.

32. *2001 Tax Legislation Law, Explanation, and Analysis*; Commerce Clearing House of Chicago, Illinois; 2001.

33. Our fiscal estimation model does not take into account the increase in EITC filers or credit amounts due to this increase in phase-out limits for married couples. However, we believe the fiscal impact will be insignificant.

Considerations for Designing a State EITC

There are a number of considerations to keep in mind when designing a state earned income tax credit. The most important are simplicity, connection with the federal EITC, and refundability. These are discussed below.

SIMPLICITY

Policy makers must be careful to avoid making the cost of complying with the tax even more burdensome than the tax itself. Thus, it is important to consider the cost of complying with a state EITC, as well as the direct costs and benefits of an EITC.³⁴

Compliance costs include the time, effort, and expense of learning about the tax, keeping records, filing records, making payments, reconciling payments and final returns, and handling any disputes or adjustments. Tax compliance costs can be particularly onerous for small companies, households, and individuals with limited income, as they are not likely to have extensive knowledge of the tax code, or access to legal and accounting assistance.

For this reason, most states have chosen to offer a state EITC that is a straightforward share of the federal earned income tax credit amount, or “piggy back” credit. This reduces the compliance burden to simply filing an additional form, based entirely on federal rules of eligibility and credit amount. While the federal EITC is not perfect, the benefits of simplicity outweigh the likely benefits to be gained from changing a Michigan EITC into a more complex calculation.

CONNECTION WITH THE FEDERAL EITC

In addition to the benefits of simplicity that can be gained by using the federal EITC as a base, there is another important reason to connect a state EITC to the federal EITC: getting the EITC into the hands of more eligible taxpayers. This is particularly critical for those not currently working, or are working in the “informal” economy.³⁵

State and federal governments have spent a great deal of resources in recent years trying to let these individuals know that the earned income tax credit is available. Michigan’s efforts have included a letter from Governor John Engler urging non-profit institutions to publicize the availability of the EITC, and a public service announcement reinforcing that message.³⁶

34. The fourth of Adam Smith’s maxims of taxation is “economy of collection.” See *Wealth of Nations* (1776), Book V, ch. II, part II.

35. We include in the “informal” economy all those who receive income from criminal activity, from work that is not documented, taxed, or recorded, household or casual work, and the many other forms of economic activity that often support those in and near poverty.

36. Letter from Governor John Engler, March 15, 1993; draft article and public service notice apparently of the same date.

REFUNDABLE TAX CREDIT

Michigan already has a number of tax credits, most notably the “homestead” or “circuit breaker” property tax credit. Some of these credits are “refundable,” meaning that a refund can be issued if the credit exceeds the amount of taxes paid.³⁷ The best known of these is the credit given for actual property taxes paid (or the imputed property tax portion of rent paid) during a year. If the amount of the credit exceeds the income tax liability of a taxpayer, the additional amount of the credit is refunded to the taxpayer. This lets taxpayers who qualify receive a net payment from the state government on their income tax.³⁸

Thus, Michigan already has a “negative income tax” under certain circumstances. Indeed, in a recent year, over 321,000 taxpayers filed Michigan income tax forms showing *zero* income. It is clear that the motivation for this filing is to receive a property tax credit, and perhaps other credits as well.³⁹

The earned income tax credit was designed to be refundable, so that it would function in some sense as a negative income tax. A refundable state EITC would add to the work incentives created by the federal credit.⁴⁰

Of course, the purpose of an EITC is primarily to offset *payroll* taxes, not income taxes. As Michigan’s state and city income taxes offer very small personal exemptions, there are a number of very low-income Michigan taxpayers who must pay local and state tax, but who have no federal income tax liability. For them, the EITC would offset some state and local income tax liability.⁴¹ Table 4, “Income Taxed by Michigan Only,” on page 27 shows the income ranges in which Michigan taxpayers

37. The farmland preservation credit and homestead property tax credit are refundable; income tax paid to Michigan cities, certain contributions, and tuition paid for college education (though not for secondary education) all qualify for nonrefundable credits.

38. The state has actually sent separate income tax refund and property tax credit checks, apparently in an effort to distinguish the property tax credit from the income tax. Regardless of whether the state government sends two separate checks or one check, this particular credit is given only against the income tax and should be considered an income tax credit, not a discount on property taxes.

39. Michigan Department of Treasury, *Executive Budget, Tax Expenditure Appendix*, Fiscal Year 1996-97; table 15.

40. The “negative income tax” was proposed in the modern era by economist Milton Friedman, as a mechanism to support low-income families without creating the disincentives to work common in social programs. See “Capitalism and Freedom”, University of Chicago Press, 1962; chapter XII.

41. Of course, if we simply wanted to eliminate the tax liability for those earning less than \$5000 per year, the straightforward way to do this would be to increase the personal exemption to that amount. This topic is discussed in “Options for Tax Reform” on page 21.

would pay income taxes to the State of Michigan even though they owed no federal income tax.

TABLE 4. Income Taxed by Michigan Only

<i>Filing Status</i>	<i>Income Range</i>
Single	\$3,000-\$7,700
Married, One Child	\$9,000-\$16,850
<i>Source: AEG Analysis</i>	
<i>Data: U.S. and Michigan Tax Laws, 2002; CCH</i>	

STATES WITH SIMILAR PROGRAMS

In 2001, fourteen states and the District of Columbia offered earned income tax credits that piggyback the federal EITC. Their programs are summarized in Table 5, “State Earned Income Tax Credits Based on the Federal EITC, Tax Year 2001,” on page 28.

TABLE 5. State Earned Income Tax Credits Based on the Federal EITC, Tax Year 2001

State	Percentage of Federal Credit
<i>Refundable credits:</i>	
Colorado	10%
District of Columbia	10%
Kansas	10%
Maryland*	16% (rising to 20% in 2004)
Massachusetts	15%
Minnesota	15% to 46%, depending on earnings
New Jersey**	15% (rising to 20% by 2003)
New York	25% (rising to 30% in 2003)
Vermont	32%
Wisconsin	4%—one child 14%—two children 43%—three children
<i>Non-refundable credits:</i>	
Iowa	6.5%
Illinois	5%
Maine	5%
Oregon	5%
Rhode Island	25.5%
<p>*Maryland also offers a non-refundable EITC set at 50% of the credit. Low-and moderate-income taxpayers in effect may claim either the refundable credit or the non-refundable credit, but not both.</p> <p>**The New Jersey credit is available only to families with income under \$20,000. Source: Center on Budget and Policy Priorities; Data current as of May 1, 2001.</p>	

LIKELY REVENUE IMPACT OF A MICHIGAN EITC

In order to estimate the effects of a Michigan EITC on the state budget, we created a fiscal estimation model that projected the number of workers who would qualify for the EITC, the number who would actually claim the credit, the average amount of the credit, the amount of new workers in the labor force attracted by the additional credit, and the taxes that these new workers would pay. This provided us with an estimate of the gross cost of the EITC—the total amount of tax credits offered—as

well as the net cost—the gross cost less the additional taxes paid by those who entered the workforce.

In addition, we compared this estimate with the other available estimates of the costs of a Michigan EITC. In preparing these estimates, we looked at an EITC set at 10% and then at 25% of the federal amount. In both cases, we assumed the entire state credit was refundable.

**ANDERSON ECONOMIC
GROUP ANALYSIS**

Table 6, “Gross and Net Costs of 10% and 25% Michigan State EITC,” on page 30 summarizes the results of our analysis of the fiscal effects of a state EITC in Michigan:

The gross costs are fairly simple to estimate, if one does not take into account any behavioral effects on workers. However, as one of the key reasons for adopting an EITC is to encourage those who are out of the labor force to come into the labor force, we believe it is important to make some estimate of the number of workers who would come into the formal economy because of the EITC, and the effects that would have on the state budget. Therefore, we have included a dynamic effect, which recognizes that the increased incentives to work would encourage some people to do so.

We’ve also included an estimate of the amount of taxes that these new workers would pay, as well as some allowance for savings in the state budget from these individuals moving off dependency and into the working world. These allowances and estimates are necessarily rough, as it is not possible to precisely estimate the behavioral changes. However, there is no doubt that there would be some behavioral change.

The tax liabilities of new workers should not be dismissed lightly. State taxes consume approximately 9.5% of the personal income in the State of Michigan.⁴² Thus, we can expect that an individual earning \$10,000 in wages would end up paying the state about \$950 in taxes. Lower income workers may pay slightly less than this average figure, as a significant amount their expenditures—such as on food and on shelter—would not be subject to the state’s 6% sales tax. However, convenience store purchases, restaurant food, lottery tickets, gasoline, cigarettes, and many other expenditures would have a significant tax charge associated with it. Even assuming that workers entering the labor force pay just 7% of their new wage earnings to the State of Michigan, a worker receiving \$10,000 in income would receive a \$2312 federal EITC and a state EITC of \$578 (at 25%). By comparison the taxpayer would have paid \$700 in state taxes. Clearly, this is a net gain position for the State of Michigan.

42. This calculation is preformed annually, as the state is required by Article 9, Section 26 of the Constitution (part of the Headlee amendment) to limit its taxes to 9.49% of state income. In fiscal year 1999 and again in 2000, the state exceeded that amount by a small margin. For example, see the analysis released by Anderson Economic Group in December 1999, available on the AEG web site at www.AndersonEconomicGroup.com; or see various Senate Fiscal Agency analyses of the state budget and revenue limit.

The model assumptions and structure are discussed in more detail in the Appendix.

Table 6 on page 30 projects the net and gross costs of a Michigan earned income credit starting in calendar year 2004, set at 10% and 25% shares of the federal EITC. The “gross” cost includes only the revenue foregone from the tax credit. The net cost includes the revenue foregone, plus expenditures saved, plus other state tax revenue. Both the gross and net cost figures assume some increase in labor force participation—and hence increases in the number of EITC filers—due to the increased incentives to work. Figure 5, “Gross and Net Costs of a 25% Michigan State EITC,” on page 31 compares the gross and net costs graphically.

TABLE 6. Gross and Net Costs of 10% and 25% Michigan State EITC

10% State Tax Credit		
<i>Years</i>	<i>MI EITC Gross Costs</i>	<i>MI EITC Net Costs</i>
2004	\$79,460,117	\$27,223,037
2005	\$80,384,072	\$28,146,992
2006	\$81,308,027	\$29,070,947
2007	\$82,231,982	\$29,994,902
2008	\$83,155,937	\$30,918,857
2009	\$83,155,937	\$30,918,857
2010	\$83,155,937	\$30,918,857
25% State Tax Credit		
<i>Years</i>	<i>MI EITC Gross Costs</i>	<i>MI EITC Net Costs</i>
2004	\$212,839,599	\$82,246,899
2005	\$215,314,478	\$84,721,778
2006	\$217,789,358	\$87,196,658
2007	\$220,264,237	\$89,671,537
2008	\$222,739,116	\$92,146,416
2009	\$222,739,116	\$92,146,416
2010	\$222,739,116	\$92,146,416
<i>Source: Anderson Economic Group fiscal simulation model.</i>		

FIGURE 5. Gross and Net Costs of a 25% Michigan State EITC

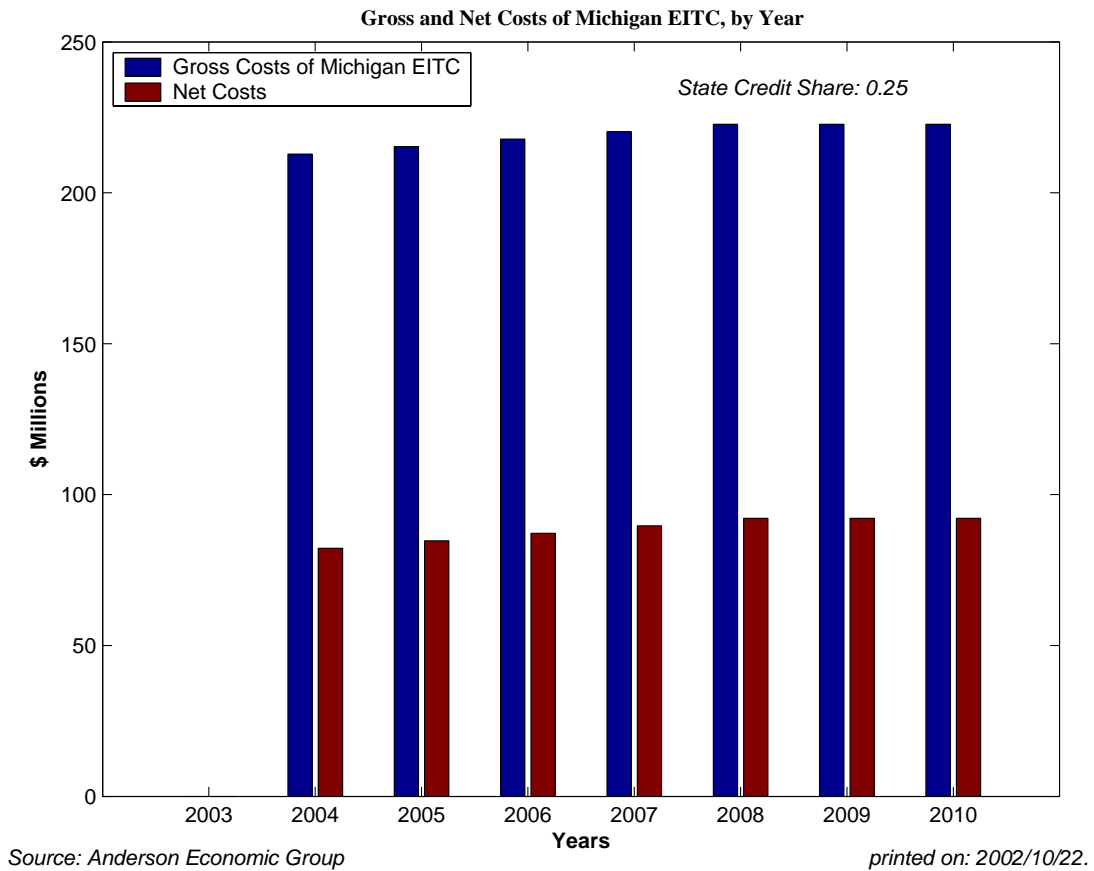

**CENTER FOR BUDGET AND
POLICY PRIORITIES’
ANALYSIS**

The Center for Budget Priorities in Washington D.C. has done an analysis of the gross costs of state EITC programs.⁴³

The report estimates the costs of a Michigan State EITC in fiscal year 2003 at \$85 million for a credit set at 10% of the federal EITC, and \$170 million for a credit set at 20% of the federal EITC. These analyses were done without including any behavioral effects and using reasonable assumptions about the filers who actually claim the credit. As estimates of the gross costs of a Michigan EITC, before any adjustment for the behavioral effects, they seem entirely reasonable.

**OTHER MICHIGAN
ANALYSES**

The Michigan legislature considered bills in 1997 that would have established a Michigan EITC.⁴⁴ The 1997 bills would have granted a Michigan earned income credit equal to 10%, 25% or 50% of the federal EITC.

One version of a bill considered in the House of Representatives would have established a Michigan 25% earned income credit. The House Fiscal Agency estimated the gross cost of the bill at \$191 million.⁴⁵ The estimate obviously did not consider any effects on encouraging work, or the impact of additional taxes paid. However, as an indicator of gross cost it is consistent with the estimates presented in this analysis.

A similar bill, HB 4499, was introduced in March of 2001. It called for a credit equal to 10% of the federal EITC.

Michigan League for Human Services. The Michigan League for Human Services reviewed IRS data on EITC filers in the State of Michigan from 1997, to estimate the number of Michigan taxpayers eligible for EITCs under a proposed state tax credit policy.⁴⁶

The League cited analysis by the Center for Budget and Policy Priorities showing that Michigan’s low-income taxpayers paid state income taxes even though they were below the poverty line.⁴⁷ Our own analysis, while not assessing the poverty threshold, is consistent with the observation that the State of Michigan taxes individuals who earn a much smaller amount than the taxable threshold for federal taxes.⁴⁸

43. Nicholas Johnson, *A Hand Up*, Center on Budget and Policy Priorities, Washington, DC, November 1999.

44. House Bill 4189 was introduced in January of 1997, and later passed the House on March 25, with a vote of 80-26. Senate Bill 26, a similar bill, was also introduced that year. Neither was enacted.

45. Fiscal Note on HB 4189, February 4, 1997.

46. “The Impact of a State Earned Income Tax Credit in Michigan,” Michigan Budget and Tax Policy Project, Michigan League for Human Services, Lansing, Michigan, February 2000.

47. “State Tax Burdens on Low-Income Families in 2000,” Center for Budget and Policy Priorities.

Work Effort and the EITC

There are two main reasons to support an earned income tax credit: to offset high payroll tax burdens on low-income workers, and to encourage those not in the labor force to begin working. This section discusses the latter rationale.

There are a variety of pathologies that afflict the chronically unemployed, including poor education and skills, crime, language, discrimination, and poor work habits. On top of these factors, child care, medical costs and insurance benefits, transportation, perverse incentives in social programs, and other economic factors discourage active work.⁴⁹

The EITC directly attacks economic factors, by increasing the after-tax rewards of going to work. It furthermore does so without the bureaucracy associated with direct social programs designed to motivate unemployed workers into the labor force. For this reason, it has attracted the support of both conservative and liberals, including in recent times President Ronald Reagan, President Bill Clinton, Texas Governor (and now President) George W. Bush, and Arizona Senator John McCain.

President Ronald Reagan, who signed into law an EITC expansion in 1986, once stated that the EITC is “the best anti-poverty, the best pro-family, the best job-creation measure to come out of Congress.”⁵⁰ President Clinton called for an expansion of the federal program for married workers and for parents with 3 or more children, while Governor Bush and Senator McCain resisted congressional calls for an implicit reduction in benefits.⁵¹

RESEARCH FINDINGS

The extent to which the EITC actually encourages workers to enter the labor force was the subject of a recent National Bureau of Economic Research paper, authored by David Neumark and William Wascher.⁵² They review the growing body of research findings, which generally support the notion that the EITC encourages workers to enter the labor force.

48. See Table 3, “Nontaxable Earnings Under Income & Payroll Taxes, 2002,” on page 22, and Table 4, “Income Taxed by Michigan Only,” on page 27.

49. For a brief discussion of welfare reform, See “The Welfare Critique” on page 38.

50. “Sweeping Tax Overhaul Now the Law,” *Chicago Tribune*, October 23, 1986; cited in Nicholas Johnson, *A Hand Up*, Washington DC, Center for Budget and Policy Priorities, 1999, p. 3.

51. President Clinton's proposal was outlined in his 2000 State of the Union Address. Governor Bush and Senator McCain opposed a bill in Congress that would stretch out the payment of the EITC over the succeeding year. See Albert R. Hunt, “One Government Program that Really Works,” *The Wall Street Journal*, 28 October 1999.

52. David Neumark and William Wascher, “Using the EITC to Help Poor Families: New Evidence and a Comparison with the Minimum Wage,” NBER working paper 7599, March 2000.

The economists then ask a much tougher question: does the EITC, or the minimum wage, better assist low-income families in their quest to climb into the middle class? Their answer is clear:

Our results indicate that there are differences in how the EITC and minimum wage policy affect earnings. Both policies appear to have positive income effects on poor families with children. However, the EITC effects are larger, evaluated on the basis of the average policy changes of the past 15 years. Complementary evidence on employment and hours effects indicates that the benefits of the EITC come about mainly by inducing labor market entry for poor families without any adult workers in the year prior to the change in the EITC. On net, these results suggest that the EITC is the more effective anti-poverty tool, especially if one considers positive work incentives as a goal of anti-poverty programs.

...
[O]ur results confirm the sense provided by previous simulation studies of the EITC and minimum wage that the former is the more effective policy for fighting poverty.⁵³

OTHER POLICY ANALYSES The EITC has been supported by a wide variety of thoughtful analyses, a few of which bear note.

Mackinac Center. The free-market-oriented Mackinac Center for Public Policy proposed creating a state EITC in Michigan, including it as one of their recommendations to reform the welfare system, in 1992:⁵⁴

13. Reduce the “work penalty” by enacting enhanced Earned Income Tax Credit plans. EITC serves as a wage supplement to parents trying to support families on low wage jobs and rewards self sufficiency rather than dependence. Michigan legislators and the governor should support expansion of the federal EITC and enact a state counterpart as well.⁵⁵

Other economists that rely on free markets have also recognized the benefits of an EITC. As this author noted previously:

Most Michiganians... are simply unaware of how the payroll tax burden affects workers at different income levels.... Easing that crushing burden on poor and working class Americans is a cause conservatives should champion.⁵⁶

St. Louis Federal Reserve Bank. This federal reserve bank, renowned for its independent thought on monetary and fiscal policy, summarized the evidence on the EITC in April of 2001:

53. Neumark and Washer, “Using the EITC to help poor families,” pp. 2, 3.

54. “New Hope for Michigan Welfare Reform,” Lawrence Reed, Randall J. Hekman, Edwin Rubenstein, Mackinac Center for Public Policy, Special Report, March 9, 1992.

55. “New Hope for Michigan Welfare Reform,” page 6. Emphasis in original.

56. Patrick L. Anderson, “Time is right for tax cut for working poor,” *The Detroit News*, 31 January 2000.

In addition to TANF [federal welfare reform], the Earned Income Tax Credit (EITC) has played an important role in raising employment among low-income individuals and alleviating poverty through wage subsidies to low-income individuals and families.... Since more than half of the EITC payments go to families with wage incomes below the poverty line, the program has also become an important instrument for reducing poverty, lifting 4.1 million people out of poverty in 1999, according to the Economic Report of the President, January 2001.⁵⁷

Indeed, the bank's review of the evidence found that a strong economy, coupled with an EITC, was more effective at reducing poverty than welfare reform:

Thus, while the TANF time limits may have pushed welfare recipients to work, the strong economy and the EITC may have done more to pull them into jobs and out of poverty.⁵⁸

Center for Budget and Policy Priorities. The liberal Center for Budget and Policy Priorities has supported and documented state earned income tax credits across the country, finding it an effective method of helping low-income workers.⁵⁹ Nicholas Johnson of the CBPP has authored a series of reports on state EITC's, including a review of the effectiveness of such credits in the year 2000.⁶⁰

57. "The Earned Income Tax Credit at Work," Ruben Hernandez-Murillo, *National Economic Trends*, St. Louis, Federal Reserve Bank of St. Louis, April 2001.

58. "The Earned Income Tax Credit at Work," cited above; the report also cites recent research by Meyer and Rosenbaum; "Making Single Mothers Work," *National Tax Journal*, December 2000, pp. 1027-61; which finds that the EITC is the most important factor in raising the employment rate for single mothers, while having less effect on other groups.

59. See, for example, Nicholas Johnson, *A Hand Up*, Center on Budget and Policy Priorities, Washington, DC, November 1999; see also more recent information on the organization's web site at <http://www.cbpp.org>

60. Nicholas Johnson, *A Hand Up: How State Earned Income Tax Credits Help Working Families Escape Poverty in 2000*, Center for Budget and Policy Priorities, November 2000; found at <http://www.cbpp.org>.

Problems With a State EITC

THE FEDERAL EITC STRUCTURE

A number of problems with state earned income tax credits stem directly from the federal earned income tax credit. The major difficulties stemming from the federal EITC include the complexity of the program, the share of federal EITC returns that contain errors, and the occasional welfare critique of the EITC.

States that wish to achieve the benefits of an enhanced EITC—the increased incentives to work, the reduction of the punishing payroll tax burden on low-income workers, and the savings when compared to other social programs—must nonetheless consider drawbacks of the federal program.

Below, we consider the error problem in the federal program, and the welfare critique occasionally voiced against the federal program.

THE ERROR PROBLEM

For the EITC, as for every other aspect of the taxes levied under the Internal Revenue Code, a fraction of taxpayers make errors on their returns. Some make these errors intentionally, while most simply make mistakes.

Complexity. There are a number of reasons why the error rate for the EITC would be significant. The first is the sheer complexity of the credit. While we presented analyses in this report of taxes paid based on income and the number of dependents, the actual definitions used by the IRS of “modified adjusted gross income” and “qualifying child” are quite complex. For example, a qualifying child must meet a relationship, an age, and a residency test, with specific definitions that clarify the relationship tests for adopted children and grand children. For 2001, you could not have more than \$2,450 in investment income, which includes royalties, rent, dividends, interest, and business earnings.⁶¹ Thus, a person who managed to scrap together \$20,000 in savings, and who put in the amount in a mutual fund, could have been excluded from claiming the credit.

Indeed, the rules are so complex that Publication 596 of the Internal Revenue Service, covering the EITC for 1999 returns, runs to 54 pages in length. The first table, described as “EITC in a nutshell” lists no less than 15 separate rules that must be followed, which are described in four complete chapters. Many of these rules are quite complex. For example, you cannot claim the EITC if your filing status is “married filing separately.” However, you may be able to file “head of household,” instead of “married filing separately.” To learn about this opportunity, Publication 596 tells prospective filers to read Publication 501.

Obviously, many errors result from simple frustration and inability to understand the program.

61. See, e.g., IRS publication 797 (revision October 2001).

IRS Activities. The IRS itself recognizes that the complexity of the EITC causes much of the problems. As indicated in its *2001 Taxpayer Advocate Report*, the EITC eligibility rules are one of the most serious problems facing taxpayers today.⁶²

DEFINITION OF PROBLEM

Taxpayers have a difficult time determining if they are eligible for the EITC.

ANALYSIS OF PROBLEM

EITC Publication 596, Earned Income Credit, contains 15 qualification rules and is more than 50 pages long. Chapter Two, which spells out the rules for a qualifying child, covers seven pages and is very complex for some taxpayers. The EITC instructions for Form 1040 are also seven pages long. The EITC section of Publication 17, Your Federal Income Tax for Individuals, takes up 14 pages.

Since EITC forms were redesigned for the 1999 tax year, math errors have dropped by 28 percent. Even with such a significant improvement, 1,471,611 taxpayers, or eight percent of all EITC claimants, either had their credit recomputed or were denied EITC for tax year 1999.

Indeed, the *Taxpayer Advocate Report* ranked EITC-related problems as the number 2, 3, and 7 most serious problems facing taxpayers today.⁶³

Actual Error Rate. The actual error rate for the EITC is also subject to some dispute. Older analyses estimated the error rate at about one-quarter, with the overpayment rate being smaller than that, and the intentional overpayment rate still smaller.⁶⁴ Another estimate of intentional abuse was provided by a January 1994 two-week study by the IRS, which concluded that 13% of EITC filers made errors that, in the IRS examiners' opinions, reflected an intent to over claim.⁶⁵

With the recent efforts, the error rate has dropped significantly. To quote again the IRS:

IRS continues to monitor the error rates in EITC returns to determine if redesigned forms and instructions implemented in tax year 1999 continue to have a positive impact. Error rates continued to decline from tax year 1999 to tax year 2000. The

62. 2001 Taxpayer Advocate Report, publication 2103, "Problem No. 3: Determining EITC Eligibility;" in section one, "most serious problems;" found at www.irs.gov.

63. Number 2 was multiple definitions of qualifying child; number 3 (discussed previously) was the EITC eligibility rules; and number 7 was the examinations for EITC eligibility.

64. See "State Earned Income Tax Credits and Error Rates," Center for Budget and Policy Priorities, February 1998; citing Internal Revenue Service, "Study of Earned Income Tax Credit Filers for 1994," April 1997.

65. See "Earned Income Credit: Targeting the Working Poor," GAO report GGD-95-122BR, March 1995, p. 14. As noted by the US General Accounting Office, this statistic is heavily based on judgment factors, dates from an old sample, and covers behavior that occurred before recent reforms designed to improve compliance.

percentage of EITC errors was 7.37 percent in tax year 1999 and 6.42 percent in tax year 2000.⁶⁶

Comparison: Business Taxes. As a rough comparison with the EITC error rate, Intuit, a maker of accounting and tax software, estimates that 30% of small businesses are fined each year for failure to properly submit one or more payroll tax forms and payment.⁶⁷ Thus, the fact that there are many errors on the returns does not indicate that “fraud” is widespread in the EITC.

CONCLUSION: THE ERROR PROBLEM

The federal EITC does suffer from a error problem, due largely to the complexity of the eligibility rules. The efforts of Congress and the IRS to simplify eligibility, and improve enforcement, have brought the error rate down significantly. However, as documented in the IRS *Taxpayer Advocate* report, more simplification is needed.

THE WELFARE CRITIQUE

Occasionally, the EITC is criticized on fundamental grounds, by claiming that it is a “welfare” program.⁶⁸ Of course, in the traditional sense of the term “welfare,” the EITC is anything but. Below we discuss the welfare critique, and demonstrate how those concerned about the pathology that welfare dependency creates should embrace the EITC.

What is “Welfare”? There has never been a federal program officially entitled “welfare.” However, the term was normally applied to federal and state programs that provided money to poor families, without any specific work requirement. The federal AFDC (Aid to Families with Dependent Children), food stamps, and other program have functioned in the past by providing cash and in-kind aid to families that fell under a certain poverty-level income test. In Michigan, the old General Assistance program provided cash aid to able-bodied adults who had little other income.

Such welfare programs were properly criticized for undermining the family structure, encouraging dependency, and creating a trap that was difficult to escape. Most of this criticism came initially from conservatives, who were finally joined by President Bill Clinton who called for “an end to welfare as we know it.” Historic welfare reform legislation at the state and federal level followed, with various states—led by Michigan and Wisconsin—making dramatic changes in their social services structure.⁶⁹ Michigan's General Assistance program was ended during Governor John Engler's first term. While there remain government programs that provide aid based on income—and numerous tax provisions that are based explicitly on

66. *2001 Taxpayer Advocacy Report*, section one, page 16; found at www.irs.gov.

67. The author's own experience with Michigan UI, SBT, and withholding taxes indicates that the penalty rate on all taxes paid by businesses in the state is probably between one-quarter and one-half. For example, Michigan levies a \$25 fine for failing to send in a quarterly UI reporting form *even if no tax is due*.

68. One such critique is voiced in a recent press release from the Institute for Policy Innovation (www.ipi.org), which may have issued a report entitled “Unmasking the EITC Welfare Masquerade” in February of 2000. Repeated efforts to obtain the study, by both phone and internet, failed.

income—the general welfare programs that existed in the 1970's have largely been abolished or fundamentally reformed.

Is the EITC “Welfare”? If we rely on the definition of “welfare” as “government aid provided without any work requirement,” then the EITC obviously fails the test. The EITC is an *earned* income tax credit, and functions largely to offset income and payroll taxes. Thus, the EITC is clearly not “welfare” in any meaningful sense, and in fact is motivated by the same philosophical underpinnings as those that motivated welfare reform.

COMPARISON WITH OTHER GOVERNMENT PROGRAMS

For most eligible workers, the EITC roughly offsets federal payroll taxes. However, it is possible, under the EITC, for a worker to receive a larger credit than he or she paid in income and payroll taxes. It is even theoretically possible, though not likely, that the credit would also offset other taxes paid to the federal and state government, such as sales taxes, property taxes, and excise taxes on tobacco, gasoline, and other items.⁷⁰ Could such unusual cases be considered “welfare”?

The answer could only be “yes,” if we take a very expansive and distorted view of “welfare.” Such a view would render a very large share of the American populace “welfare recipients.” Consider, for a moment, that virtually all current retirees in America receive Social Security benefits that exceed the invested value of the social security taxes paid on their behalf during their working lifetimes.⁷¹ Does this convert retirees into “welfare recipients”? Clearly not.

CONCLUSION: THE WELFARE CRITIQUE

After reviewing the evidence, it is apparent that the EITC is not a welfare program. Instead, it is a program that offsets the huge income and payroll tax burdens of those that choose to work.

69. The federal Welfare Reform Act of 1996 brought dramatic changes at the federal level, resulting in a 30% drop in the number of welfare recipients. States have taken a variety of approaches at encouraging work rather than welfare. The Hudson Institute, a national think tank based in Indiana, has a number of online resources on state and federal welfare reform; see <http://www.hudson.org>. Of particular interest are a debate on the efficacy of welfare reform, also available at www.IntellectualCapital.com.

70. To see how unlikely this is, consider a worker with annual earnings of \$10,000, who qualified for an EITC of \$2312. The same worker paid income and payroll taxes of about \$1,985. If he or she spent \$5,000 on goods taxable at 6%, that's another \$300 in taxes. Excise taxes on gasoline, tobacco, and other goods, as well as property taxes embedded in rent, would add her total taxes paid.

71. Social security taxes paid by retiring workers have been generally insufficient to pay for their benefits. The taxes paid by workers today are not segregated for the benefits those same workers will receive when they retire. They are used largely to pay benefits for retirees today.

Appendix: Fiscal Estimation Model for a State EITC

The author created a simulation model to project the gross and net costs of a state earned income tax credit for the State of Michigan. The model allows for dynamic effects, such as more earnings due to increased incentives to work, and for the measurement of tax revenue from new filers alone. The following table lists the key parameters used in the simulations:

TABLE 7. Assumptions in Michigan Fiscal Simulation

Parameter	Amount
Base amount of federal EITC filers; from IRS SOI data, returns processed in 2001	549,864
Amount of federal credits; from IRS SOI data, returns processed in 2001	\$880.0 million
Average earnings of new filers	\$10,000
Ratio of tax credit amounts for new and existing filers	1:1
Total tax rate on income from new filers	9.0%
Saved social program expenses, per new filer	\$1000
Elasticity of labor supply eligible for EITC with respect to state tax credit share	0.5
State credit as share of federal credit	10% and 25%, in separate simulations

Important factors in the simulation include:

- The amount of induced growth in workers eligible for an EITC was estimated by multiplying the elasticity parameter by the amount of the tax credit share. For example, a 0.5 elasticity multiplied by a 10% tax share meant a 5% increase in workers eligible for an EITC. These workers are assumed to come from outside the current workforce.
- The utilization rate for the state EITC was assumed to start at 85% and grow to 90%.
- Aside from the dynamic effect of encouraging labor force participation, along with increased utilization of the state credit, no other growth in the number of EITC filers was assumed.
- We do not take into account an increase in filers or credit amounts due to the increase in phase-out limits for married couples under the Tax Relief Act of 2001.
- The non-linearity of the EITC as a function of income was not considered in the model. Because the credit increases, and then decreases, as a function of income, additional labor force participation would result in some workers paying more net taxes, and some paying less.

Figure 6, “EITC Fiscal Estimation Model,” on page 41 illustrates the structure of the simulation model.

FIGURE 6. EITC Fiscal Estimation Model

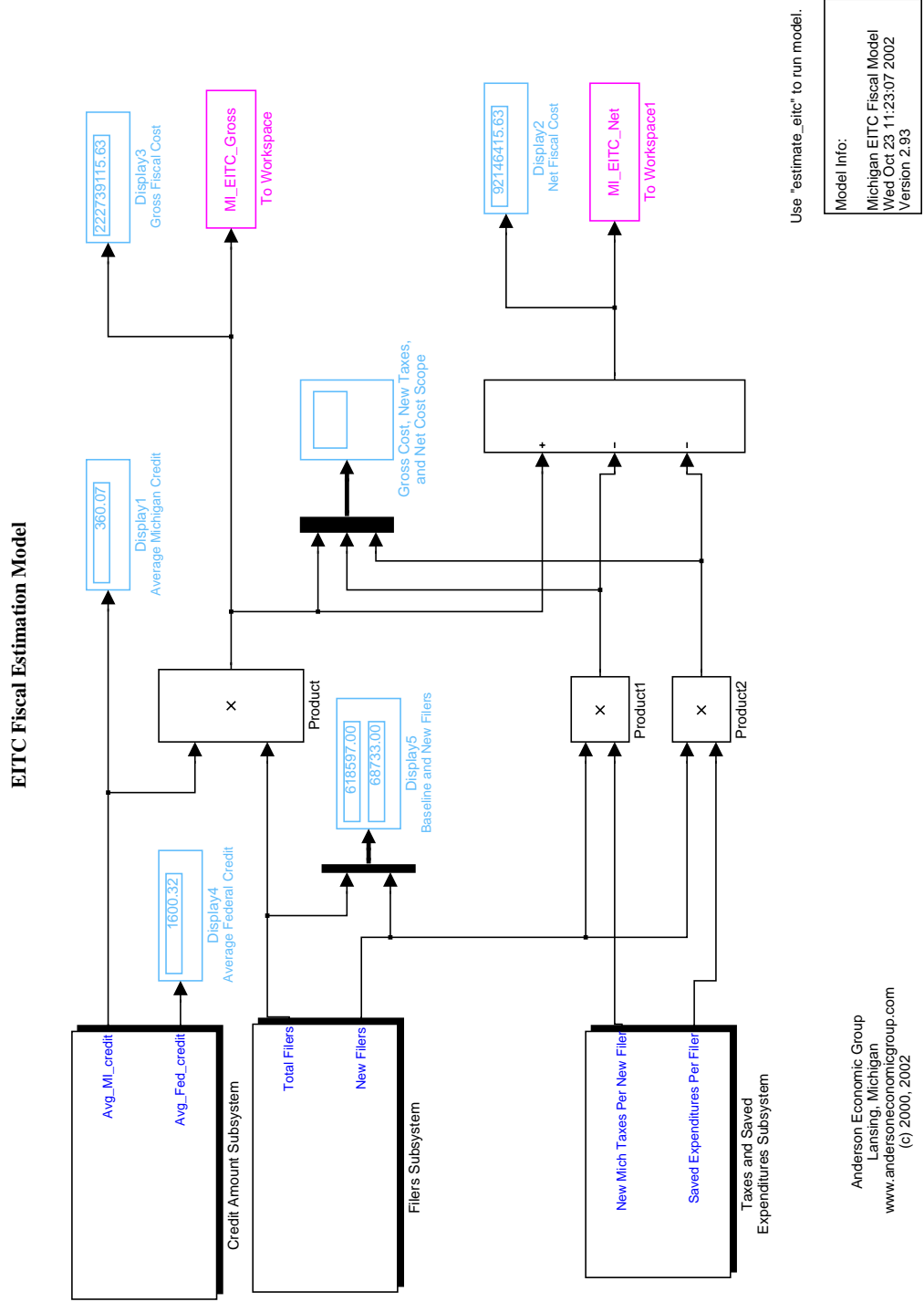

*Michigan
Catholic
Conference* 